

Raiki

our own design for your own interior

Tsuji Sangyo co.,ltd.

雷切

Raiki : 雷切 (ライキ)

日本刀の「雷切」は、雷、もしくは雷神を切ったとされる名刀

Brand Concept

古来より日本人が持つ美意識

日本人が古来より受け継ぐ美意識を纏う“Raiki”。
極限まで無駄を削り込むことで生まれる緊張感とその場の質を最大限に際立たせます。
洗練を極めた“Raiki”は主張することなく空間と調和し“場”の質をも高めます。



"omihachiman sunset" © Yoshinori Yamazaki (Licensed under CC BY 4.0) <https://creativecommons.org/licenses/by/4.0/>

見わたせば
花も紅葉も
なかりけり
浦の苫屋の
秋の夕暮れ

Product Lineup

The Door Slide Door



The Door Pivot Door



The Shelf



The Cabinet



Letre



Teni



Lounge



6

The Door

Slide Door



Slide Door (Type-S "Sukiya") frame color : Platinum Beige
glass color : Dark Bronze

¥1,200,000

The Door

7

Slide Door

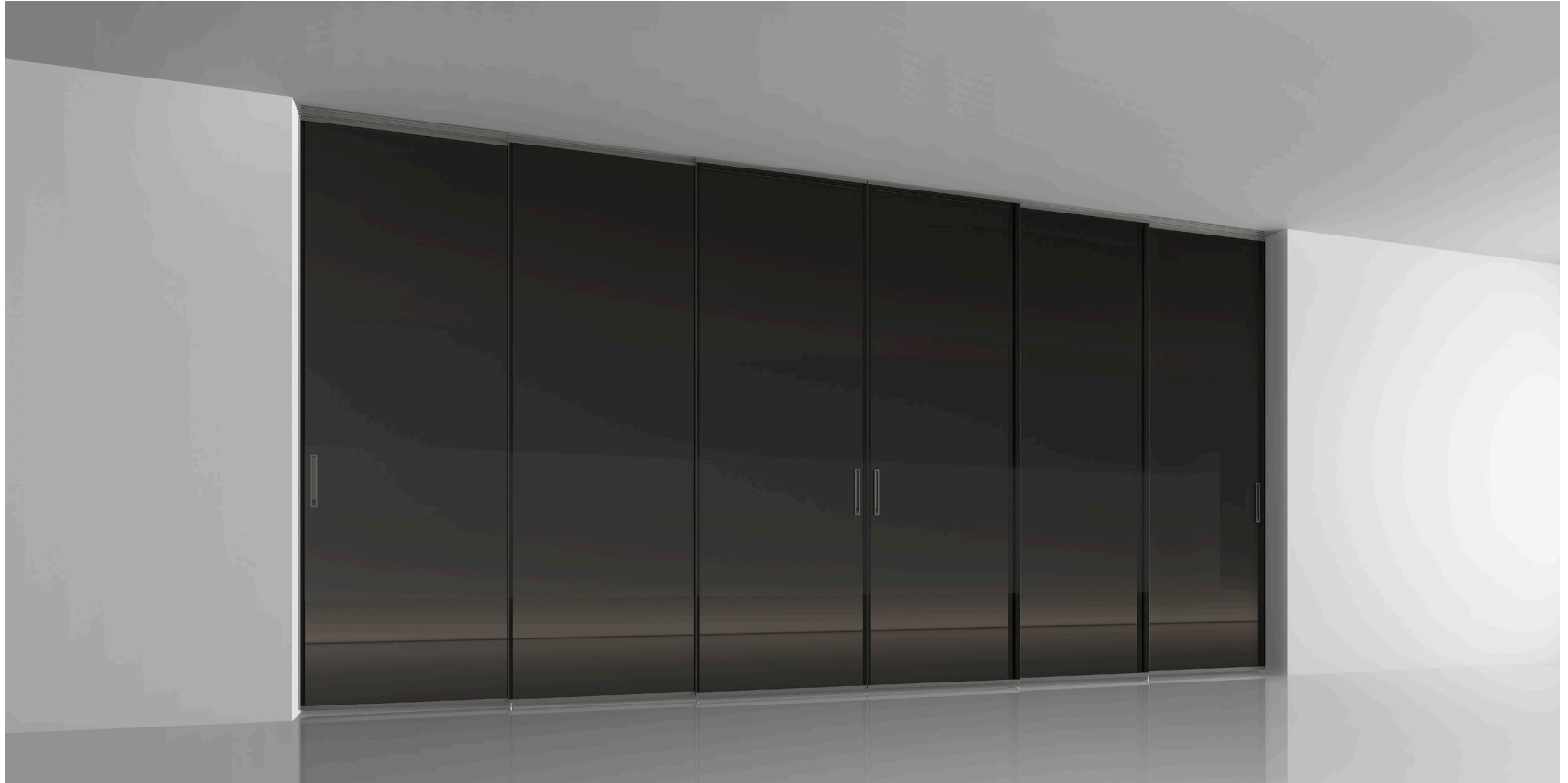

Slide Door (Type-B "Bozu") frame color : Granite
glass color : Charcoal Grey(×2)

¥1,320,000

The Door

Slide Door



Slide Door (Type-S "Sukiya") frame color : Earth Black
glass color : Clear

¥1,380,000

The Door

9

Pivot Door + Fix Panel

Raiki Loves **MARAZZI**



Pivot Door + Fix (Type-B "Bozu") frame color : Platinum Beige
panel : Golden White

¥2,800,000

The Door

Slide Door



Slide Door (Type-S "Sukiya") frame color : Earth Black
glass color : Grey

¥810,000

The Door

11

Slide Door - Trapezio

Raiki Loves • Hanamura



Slide Door (Type-S "Trapezio") frame color : Platinum Beige
glass color : Clear

Trapezio 片面 ¥4,200,000
Trapezio 両面 ¥7,080,000

The Door

Slide Door -112



Slide Door (Type-S "112") frame color : Maroon Brown
glass color : Clear

¥1,360,000

What is "Fibonacci" ?

フィボナッチ数列とは、イタリアの数学者レオナルド＝フィボナッチが唱えた数列で、その隣り合った数の比は、現代デザインにおいて美しい形を表す指標ともいわれる「黄金比(=1:1.618...)」に近似していきます。さらに、その黄金比の縦横比率でできた長方形にあるすべての正方形の列において、角の点を滑らかにつないでいくと「黄金螺旋(らせん)」と呼ばれる渦巻き状の螺旋を描くことができます。

江戸期を代表する浮世絵の名作「富嶽三十六景 神奈川沖浪裏」やミロのヴィーナス、モナリザなどの芸術作品にも見られるこの黄金比は、作者が意図していたか否かは別として、人が本能的に美しいと感じる比率であるといえるでしょう。

Raikiシリーズの新作「Raiki 112」もこのフィボナッチ数列から導き出される「黄金比(黄金螺旋くらせん)」をルールとしてデザインされています。

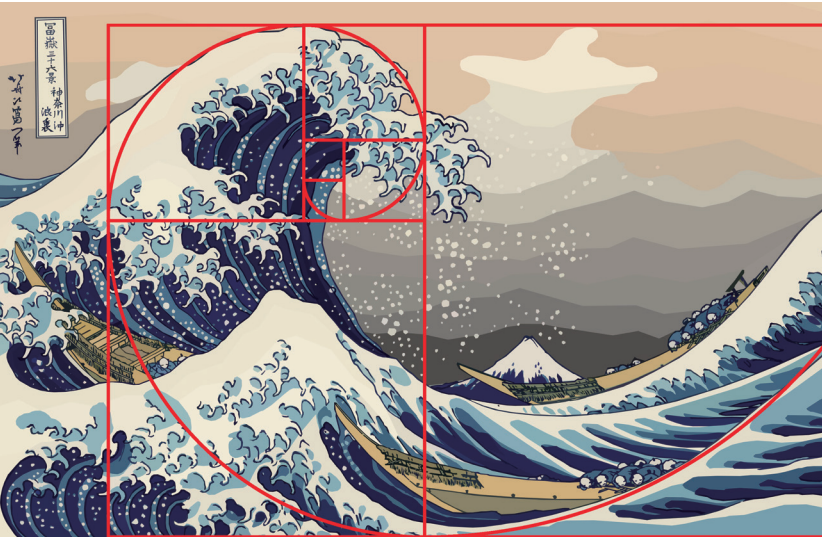

葛飾北斎「富嶽三十六景 神奈川沖浪裏」

THE Fibonacci Sequence

0, 1, 1, 2, 3, 5, 8, 13, 21, 34, 55, 89, 144, 233, 377...

$1 \div 1 = 1$	$13 \div 8 = 1.625$
$2 \div 1 = 2$	$21 \div 13 = 1.615$
$3 \div 2 = 1.5$	$34 \div 21 = 1.619$
$5 \div 3 = 1.666$	$55 \div 34 = 1.617$
$8 \div 5 = 1.6$	

Golden Ratio



1.618

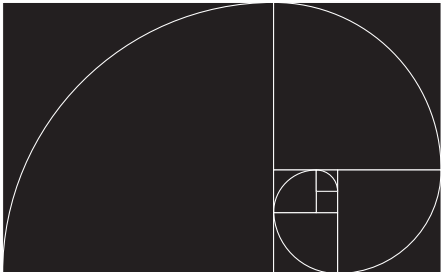
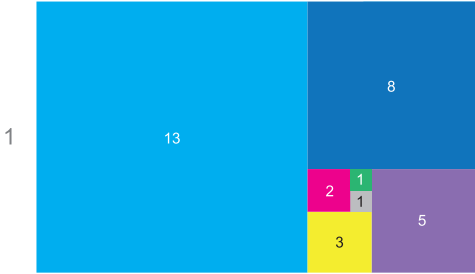

The Door

Slide Door -Coma

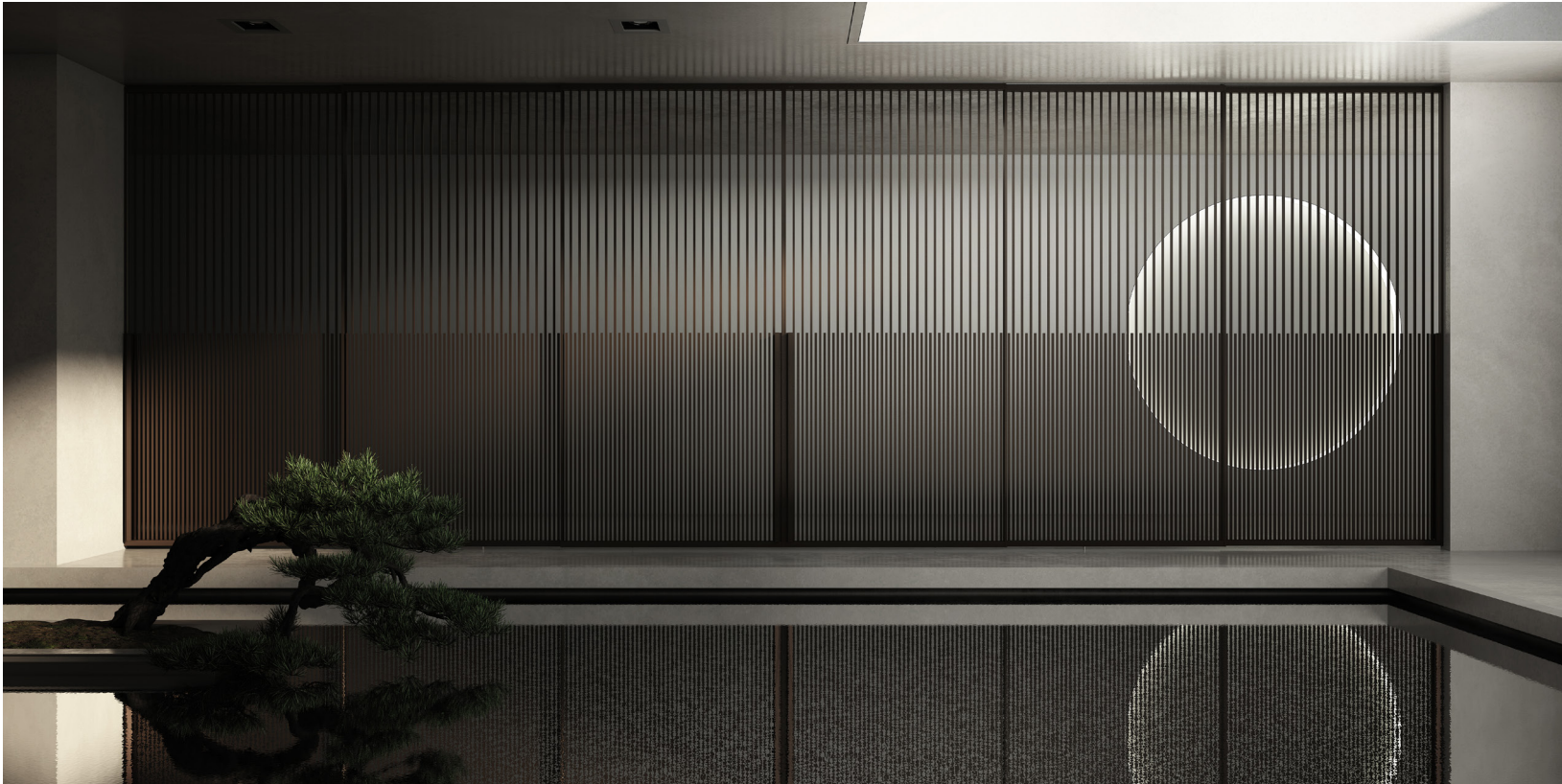

Slide Door (Type-S "Coma") frame color : Maroon Brown
glass color : Clear

¥6,200,000

駒寄とComa

“駒寄（こまよせ）”とは、京町家などに見られる人馬の侵入を防ぐための格子柵。その境界は“あいまい”で、一見乗り越えようと思えば簡単に乗り越えられるような簡易的な柵に見えます。しかし、その境界はこの線を踏み越えてはいけないという暗黙の精神的な枷「かせ」となり、家族、使用人、訪問客、それぞれの関係の距離を黙して棲み分けします。

Comaは「目隠し」と「透過性」という二面性を持つ間仕切りで“あいまい”に空間を切り分け、その空間の質を変化させます。この手法は現代でも日本人に好まれ多くの建築に取り入れられています。



The Door

Pivot Door + Fix Panel

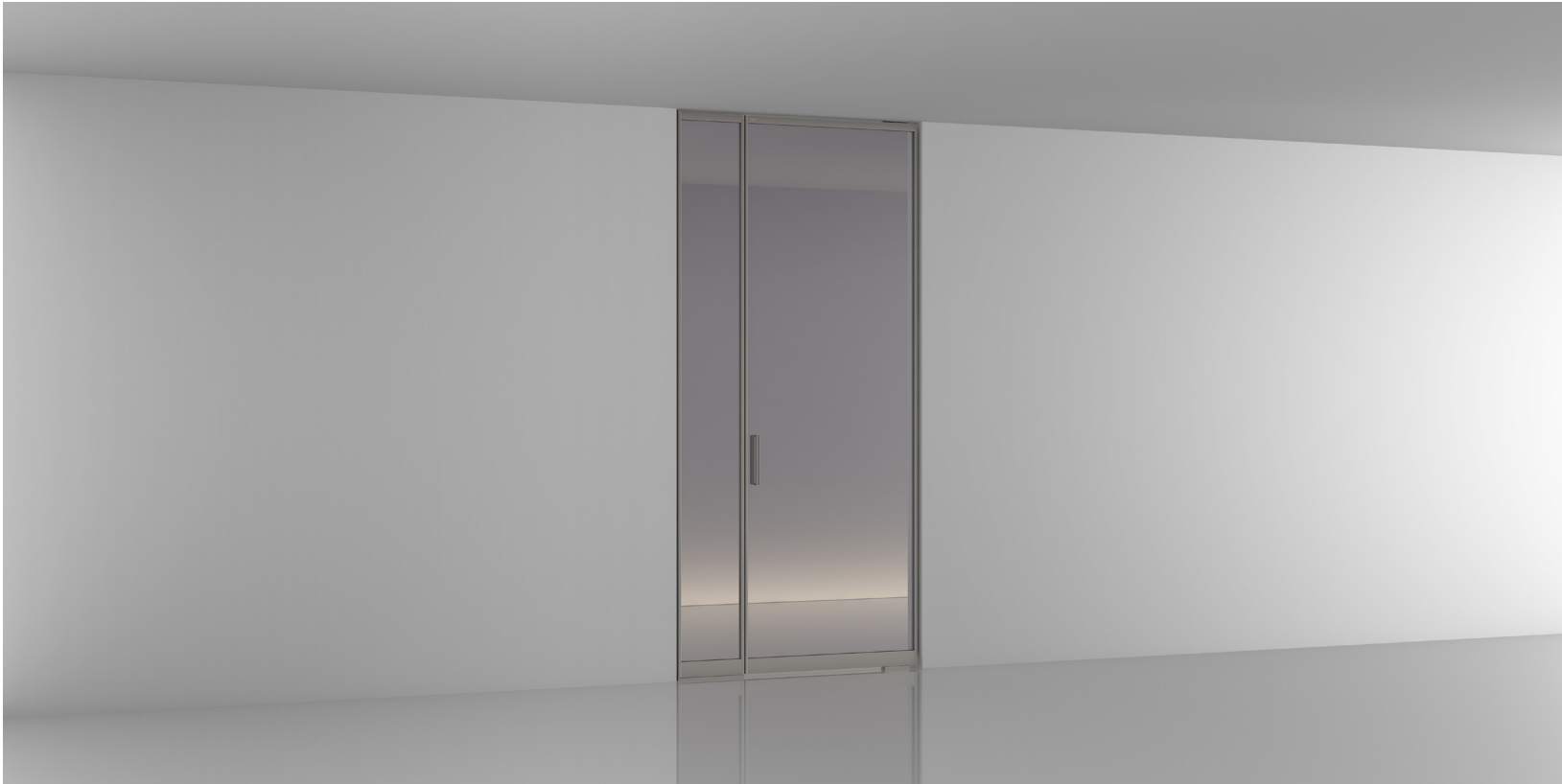

Pivot Door + Fix (Type-S "Sukiya") frame color : Granite
glass color : Grey

¥460,000

The Door

17

Pivot Door



Pivot Door (Type-B "Bozu") frame color : Earth Black
glass color : Charcoal Grey(×2)

¥320,000

The Door

Pivot Door + Trapezio

Raiki Loves • Hanamura

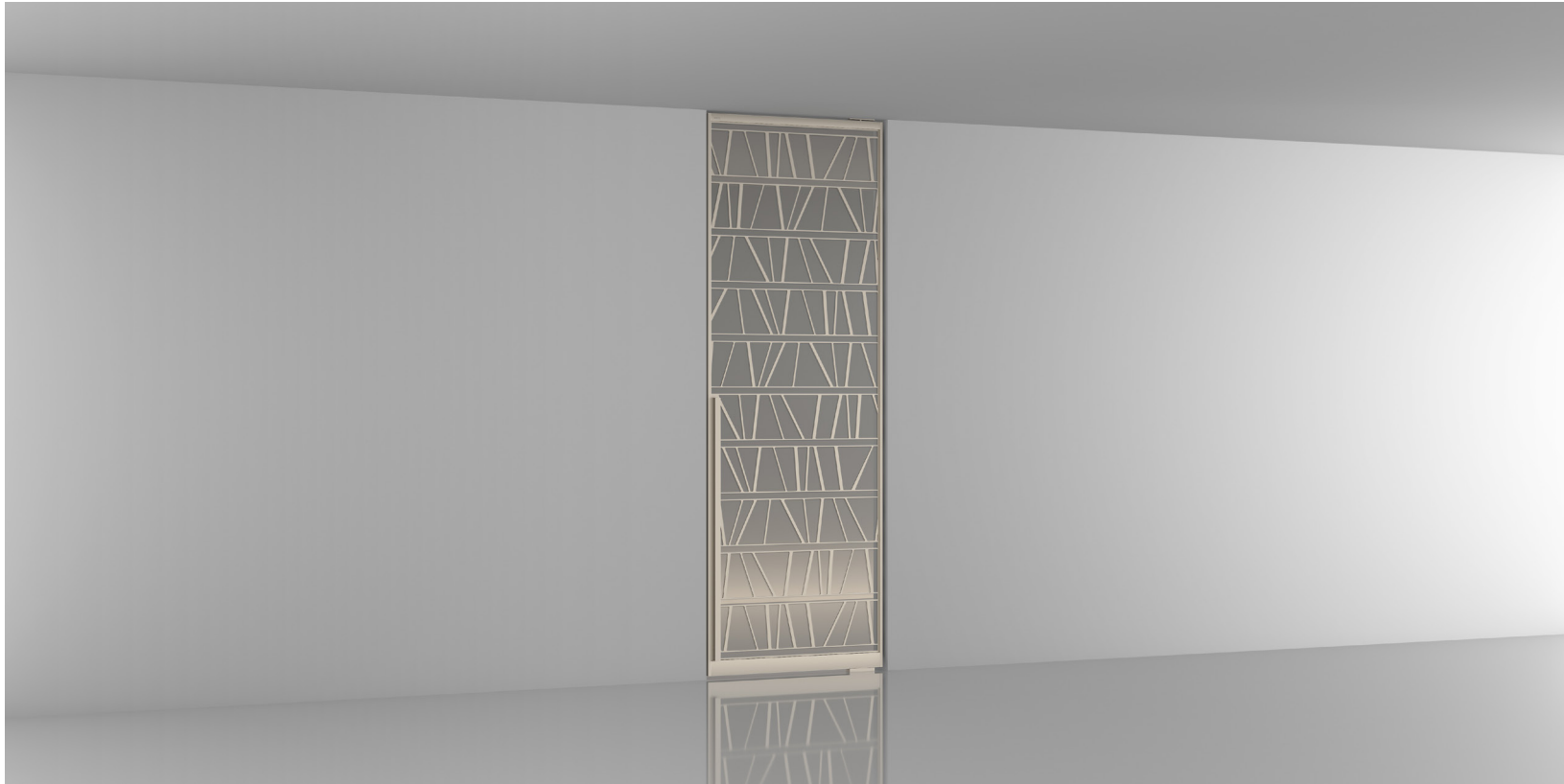

Pivot Door (Type-S "Trapezio")
frame color : Platinum Beige
glass color : Bronze

¥830,000 Trapezio 片面
¥1,310,000 Trapezio 両面

The Door

19

Pivot Door + Marazzi

Raiki Loves **MARAZZI**



Pivot Door (Type-B "Bozu") frame color : Platinum Beige
panel : Golden White

¥540,000

The Door

Pivot Door + Fix Panel - 112

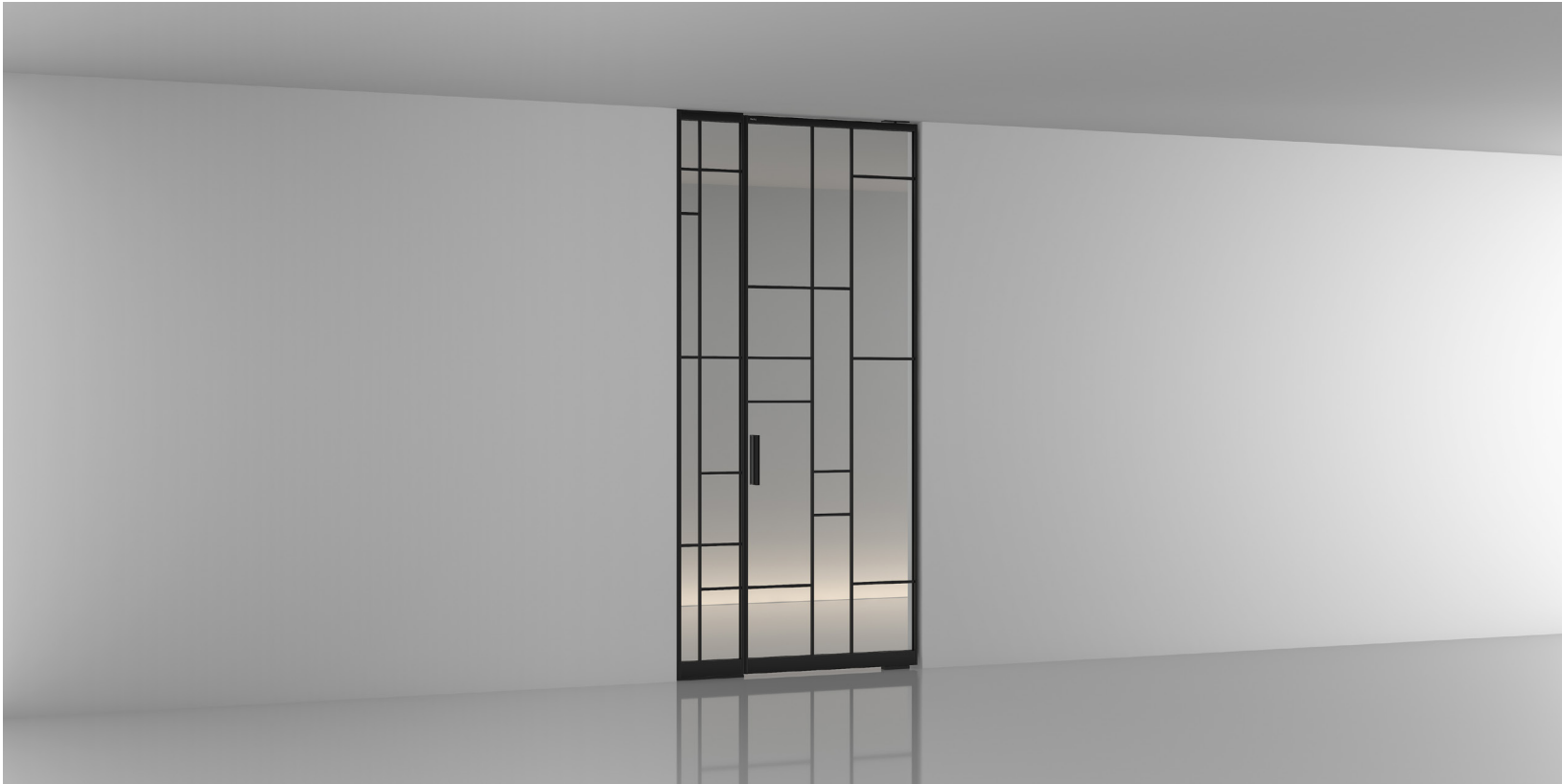

Pivot Door (Type-S "112")

frame color : Earth Black
glass color : Clear

¥720,000



The Door

Pivot Door



Pivot Door (Type-S “Sukiya”) frame color : Platinum Beige
glass color : Clear

¥290,000

The Door

Pivot Door



Pivot Door (Type-S "Sukiya") frame color : Earth Black
glass color : Clear

¥410,000

The Door

Pivot Door



Pivot Door (Type-S "112")

frame color : Earth Black
glass color : Clear

¥1,120,000

The Door

Slide Door

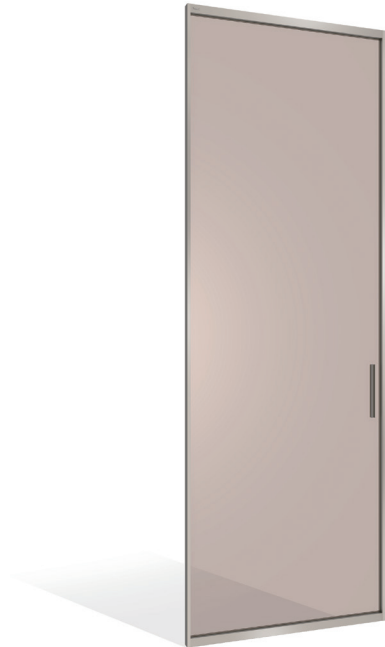

¥200,000



¥220,000

Type-S 数寄屋 “Sukiya”

安土桃山時代から、今もなお発展し続ける
日本固有の繊細美「数寄屋障子」より

frame color : Platinum Beige
glass color : Bronze



Type-B 坊主 “Bozu”

利休より受け継がれる“侘”の象徴
「坊主襖」より

frame color : Granite
glass color : Charcoal Grey



Type-S "Sukiya"

frame

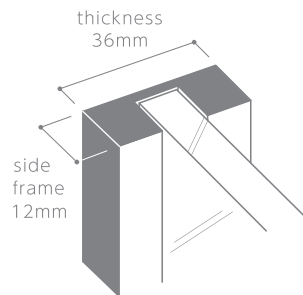
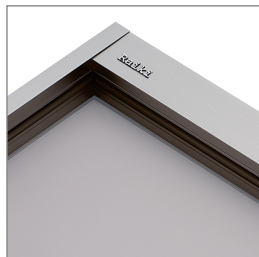

Type-B "Bozu"

frame

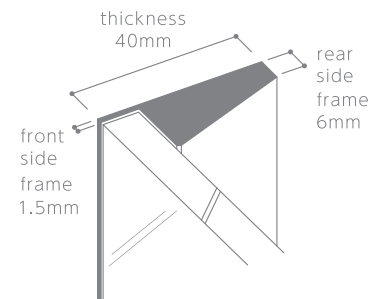
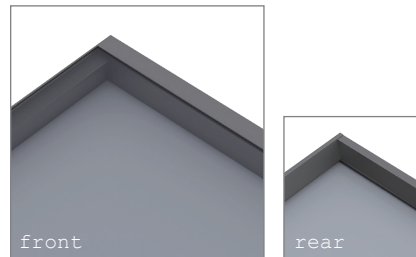

handle (Slide Door)



B handle (Pivot Door) *option

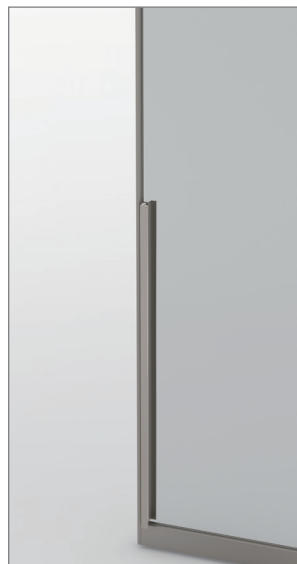

handle (Pivot Door)

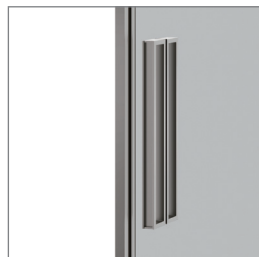

handle (Slide Door)



handle (Pivot Door)



The Door

Slide Door

Type-S

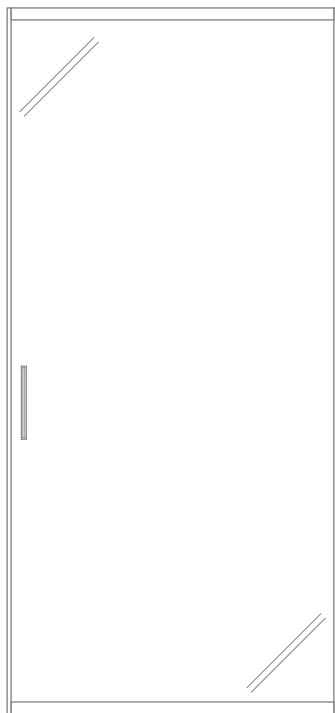

MAX DH 3,000
MAX DW1,500

Type-B



MAX DH 3,000
MAX DW1,500

※扉の製作可能寸法は、ガラスの種類・諸条件によって異なります。詳しくはお問い合わせ下さい。

※Slide DoorのMIN DWはType-S、Type-B共通でDW700です。

Glass Color

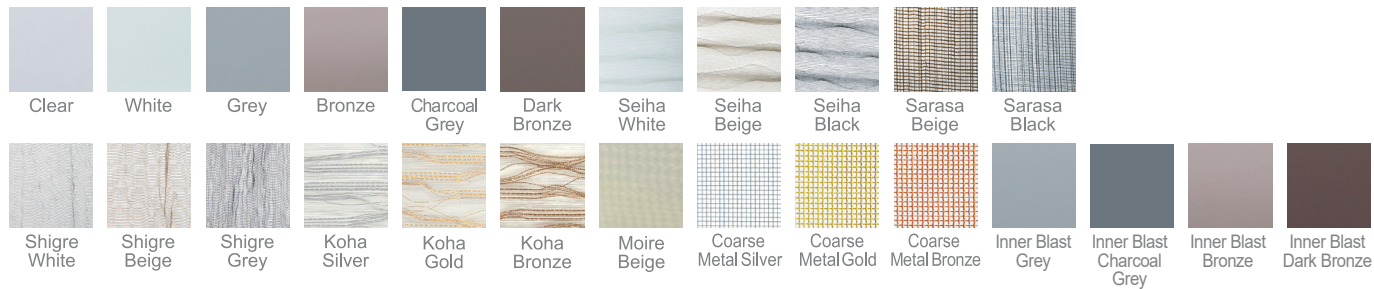

Stone Panel

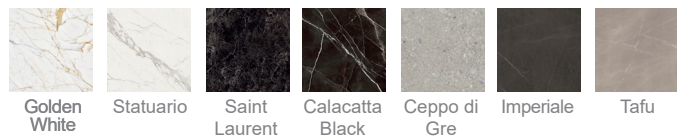

※Clear, Grey, Bronze, Moire Beigelは Type-BIには使用できません。
 ※Stone Panelの詳細はP63をご覧ください。

Frame Color



The Door

Pivot Door

Type-S

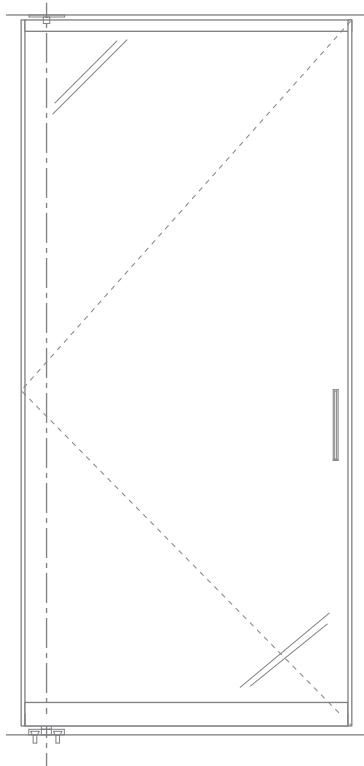

MAX DH 3,000
MAX DW1,500

Type-B

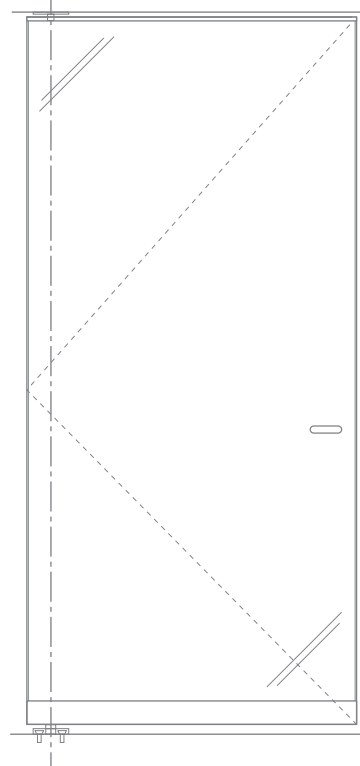

MAX DH 3,000
MAX DW1,500

- ※上記MAX DW、DHは寸法範囲内で100kg以下となります。
- ※扉の製作可能寸法は、ガラスの種類・諸条件によって異なります。詳しくはお問い合わせ下さい。
- ※回転軸～戸先がDW700以下の場合、開閉が重くなる可能性があります。

Glass Color

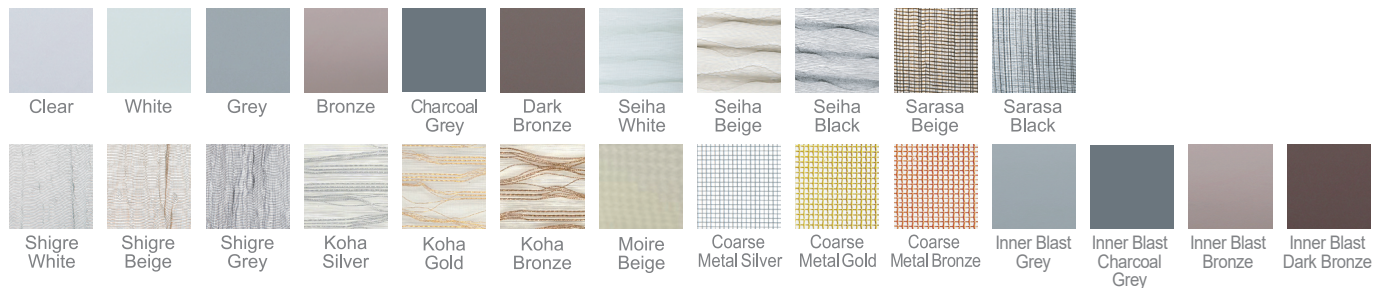

Stone Panel

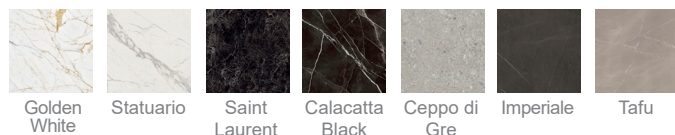

※Clear、Grey、Bronze、Moire Beigelは Type-BIには使用できません。
 ※Stone Panelの詳細はP63をご覧ください。

Frame Color



Imitation Leather

Raiki The DoorのパネルがStone Panelの場合、裏面仕上げはイミテーションレザー仕上げになります。

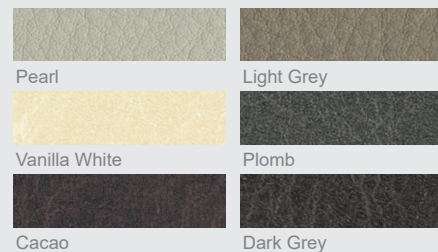

扉裏面：
Imitation Leather



Pivot Door フロアヒンジ位置

ヒンジ位置は、一般的なヒンジ位置である「エッジピボット」と、センター寄りで戸尻側/戸先側の比率が1:2.415となる「インナーピボット」の2種類が選べます。

エッジピボット

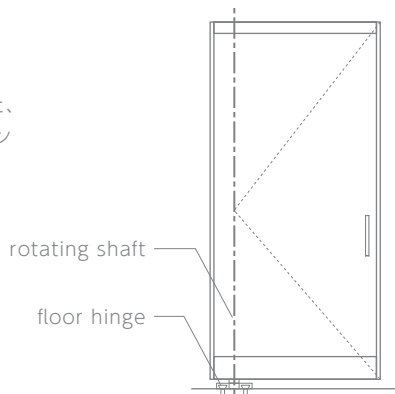

DW700~1,300

インナーピボット

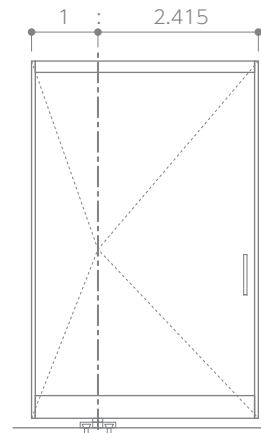

DW1,300~2,000

※1,300以下は開閉が重くなるため推奨しません。

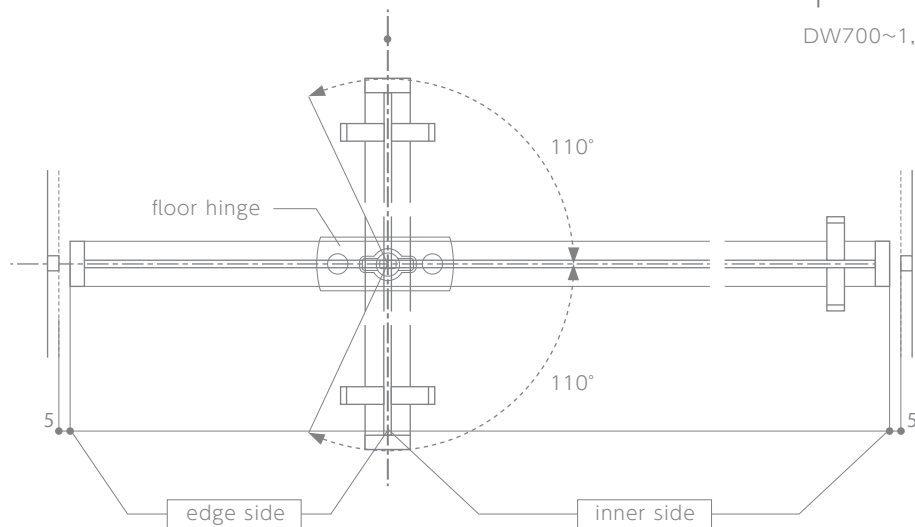

エッジピボット : 67 mm

インナーピボット : 380~585 mm

エッジピボット : 633~1,233 mm

インナーピボット : 920~1,415 mm

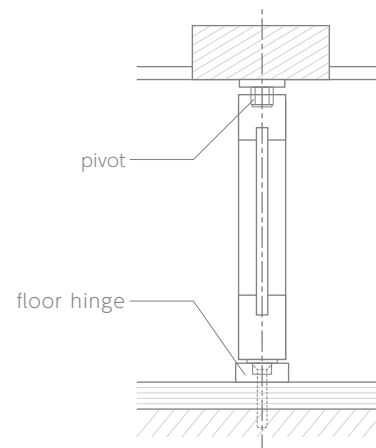

ユニバーサルデザイン

一般的なドアは、ドアを開ける際に一度立ち止まりハンドルをつかむ動作が必要となるため、身体のバランスを崩しやすく、動作にムダが生じてしまいます。一方、Raiki Pivot Doorはドアの前でいったん立ち止まることなく、身体に負担がかからない状態で開閉動作をするため、無理のない動作でラクに出入りすることができます。

実 験

- A : 一旦立ち止まり、ハンドルをつかまなくてはならないため、身体のバランスを崩しやすく動作に無駄が生まれます。
- B : 立ち止まる必要がなく、歩き出した流れのまま開閉を行うことができるので身体への負担がなく安定した状態で開閉操作が可能です。

実 験 条 件

- 被験者：2名（利き腕は全員右）
- A：一般的なドア → DH2400 × DW800
- B：Raiki Pivot Door → DH2400 × DW800

室内側、廊下側からそれぞれ扉の開閉を行い、通過時間、VTR撮影を実施。（通過時間の計測は、基準点通過時間をストップウォッチで計測）

一般的なドアの場合

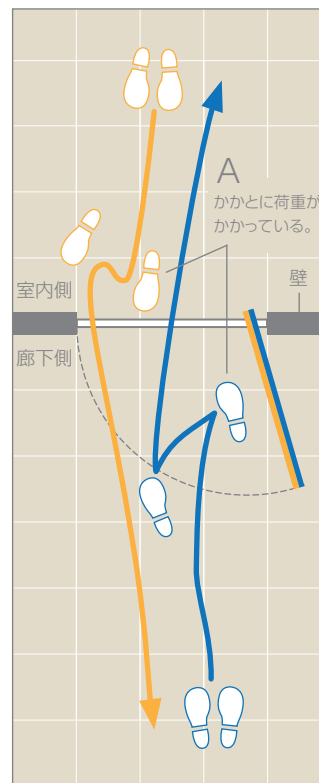

Raiki Pivot Doorの場合

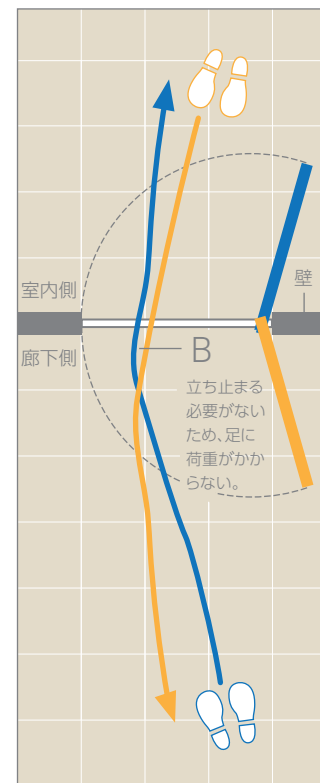

Glass

Inner Blast Glass



<インナーブラストガラスの構造>

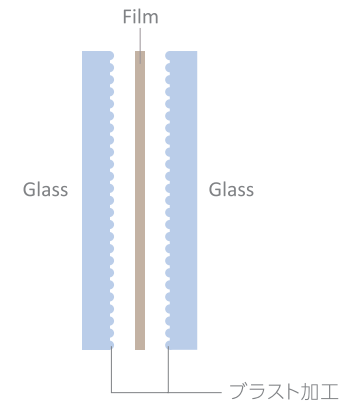

合わせガラスの内側をブラスト加工することにより、ガラスの艶を失うことなく視線を和らげることができます（完全に視線を遮ることはできないのでトイレ脱衣室等の完全なプライベート空間には推奨できません）

※インナーブラストガラスの最大寸法は、MAX DW1,000、MAX DH2,400となります。

カラーガラスとインナーブラストガラスの距離による見え方の違いです。

Color Glass

0.5m



Inner Blast Glass

0.5m



1.0m



2.0m



5.0m



The Cabinet



Raiki The Cabinet frame color : Platinum Beige
glass color : Clear

¥6,030,000

The Cabinet



Raiki The Cabinet frame color : Platinum Beige
 glass color : Clear

¥1,620,000 × 2

The Cabinet

Detail

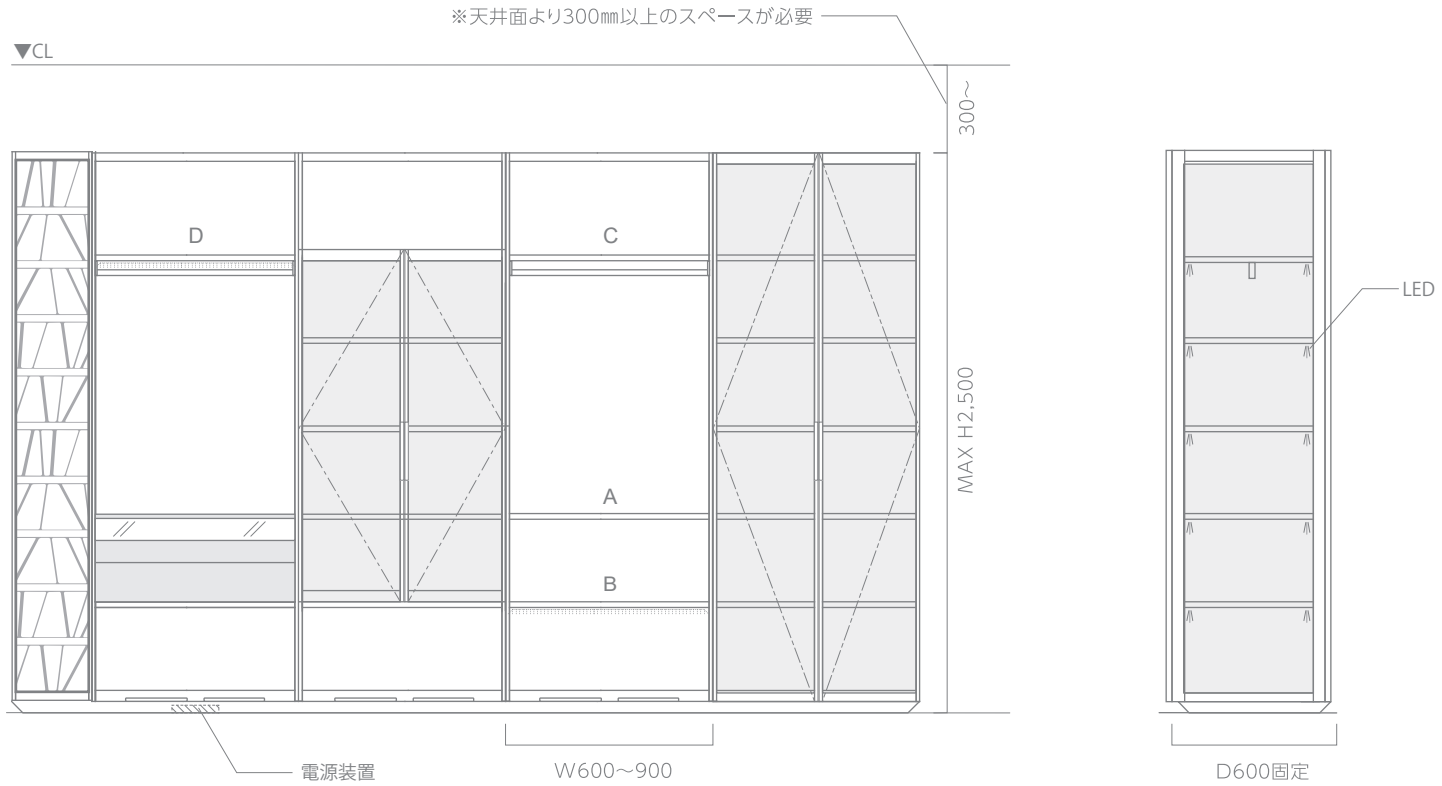

Shelf Board

A Glass Board (FIX)
¥50,000



B Glass Board (FIX+LED)
¥80,000



C Glass Board (FIX+H.P.)
¥70,000

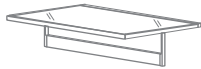

D Glass Board (FIX+H.P.+LED)
¥100,000



Others

Design Panel
¥270,000



Door
¥110,000 ×2

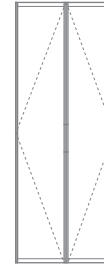

Middle Door
¥100,000 ×2

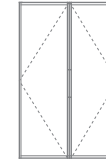

Chest
¥480,000

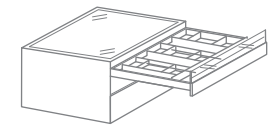

Wood Panel (Olefin Sheet) ※市販品のオレフィンシートでも製作可能です。

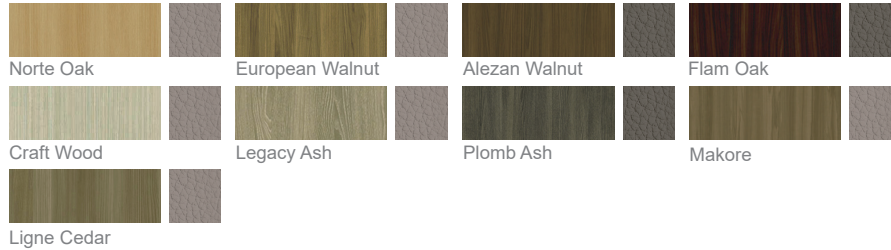

Frame Color

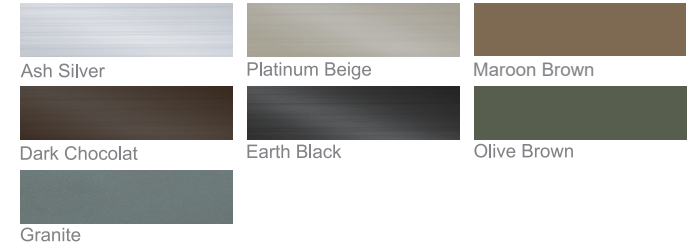

Glass Color



※左記の他に、P27のガラスであれば使用可能です。

The Shelf

43



Raiki The Shelf frame color : Granite
glass color : Clear

¥4,670,000

The Shelf

45

Raiki Loves • Hanamura



Raiki The Shelf
frame color : Earth Black
glass color : Clear

¥3,660,000

The Shelf



Raiki The Shelf frame color : Earth Black
 glass color : Clear

¥5,310,000



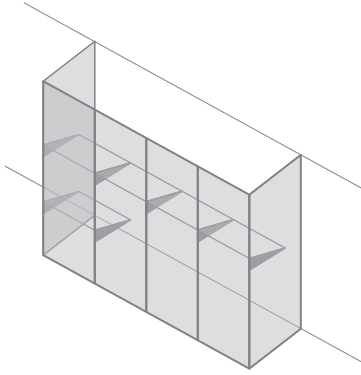
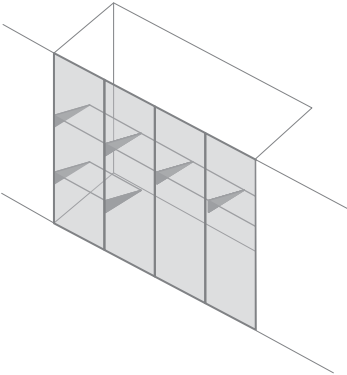
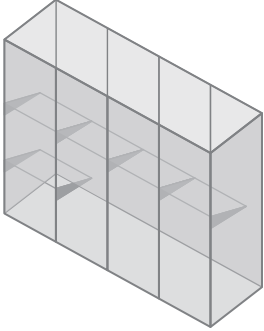
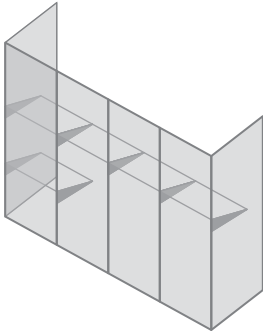
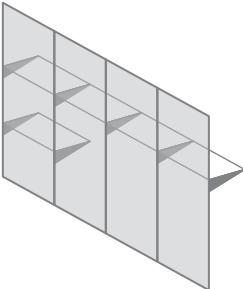

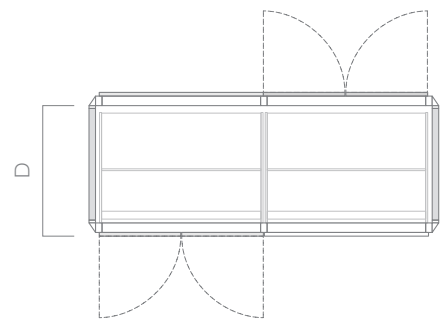
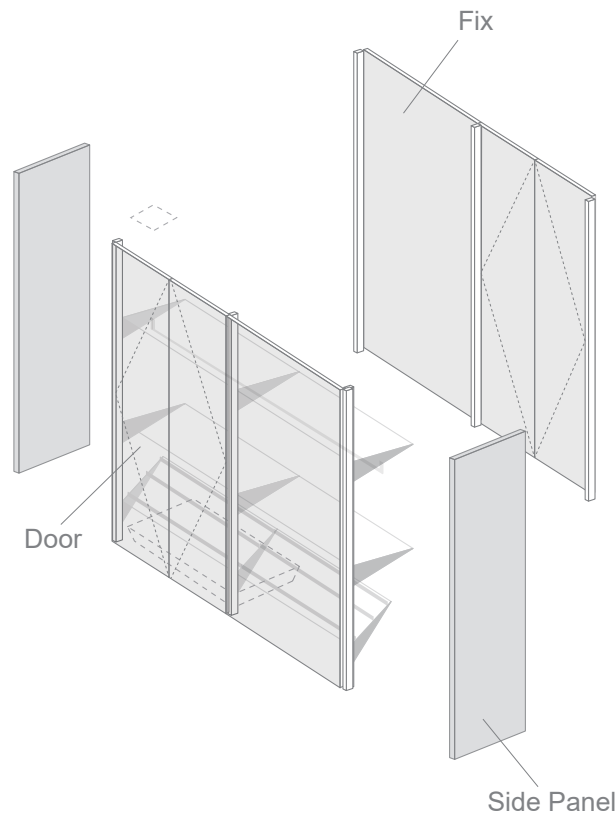
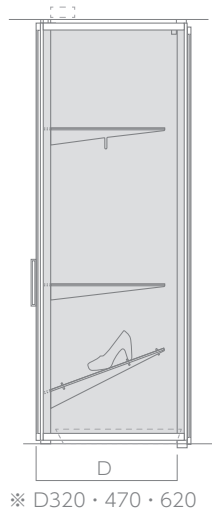
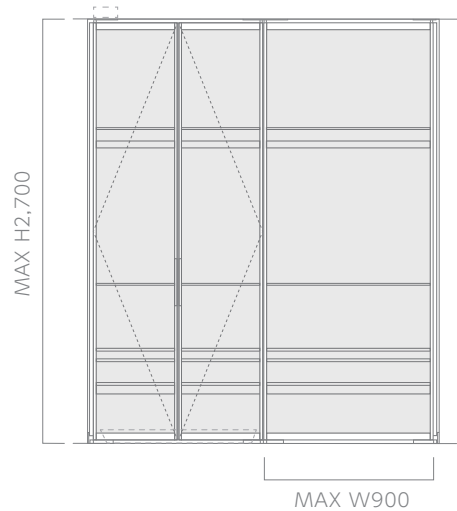

Layout Pattern



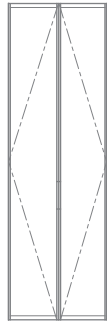





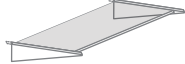
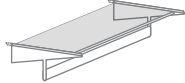
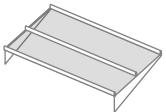
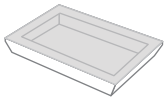

The Shelf









Raiki The Shelf
(W1800×H2500、color glass)
¥2,400,000

Door	Fix	Side Panel				Option	
		Trapezio 	Stripe 	112 	Color Glass 		Glass Board ¥70,000
¥110,000 ×2枚	¥140,000	¥600,000	¥230,000	¥330,000	¥230,000		Glass Board (H.P.) ¥80,000
							Shoes Rack ¥70,000
							Baseplate ¥40,000

Glass Color

 Clear	 White	 Grey	 Bronze	 Charcoal Grey	 Dark Bronze
 Coarse Metal Silver	 Coarse Metal Gold	 Coarse Metal Bronze			

Frame Color

 Ash Silver	 Platinum Beige	 Maroon Brown
 Dark Chocolat	 Earth Black	 Olive Brown
 Granite		

※DH2,500以上は特注対応になります。
 ※棚の可動をご希望の場合は、事前にご相談ください。
 ※上記のほかに、P27のガラスであれば使用可能です。

Letre



Letre frame color : Platinum Beige
panel : Makore + Imperiale

¥3,400,000

Letre

51



Letre frame color : Platinum Beige
panel : Makore + Imperiale

Letre ¥4,600,000
98 Ottoman ¥380,000

Letre



Letre frame color : Platinum Beige
 panel : Makore

Drawer W900 ¥700,000
98 Ottoman ¥380,000



Letre

Detail

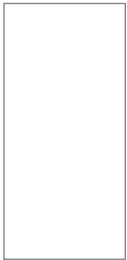
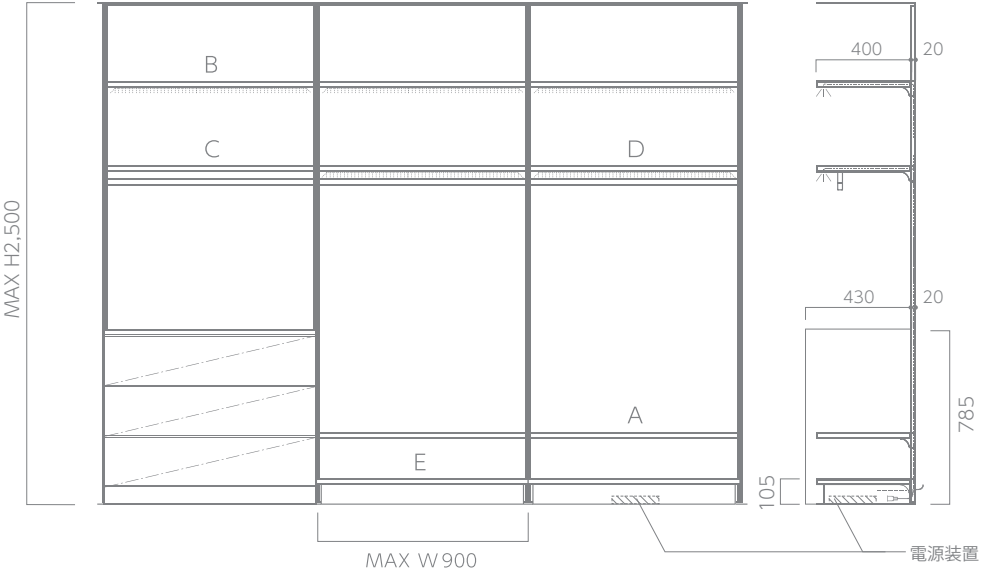
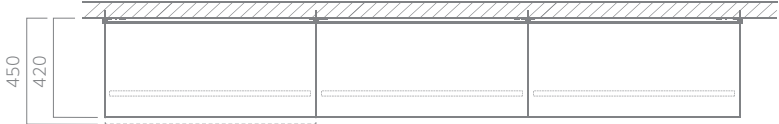

Wood Panel
¥80,000 /列



Stone Panel
¥400,000 /列

Option



A Board
¥40,000



B Board (LED)
¥70,000



C Board (H.P.)
¥60,000



D Board (LED + H.P.)
¥90,000



E Baseplate
¥40,000

Stone Panel

Raiki Loves **MARAZZI** Max Size 900×2,700 ※Imperiale と Ceppo di Gre のみMax Size 1,200×2,400

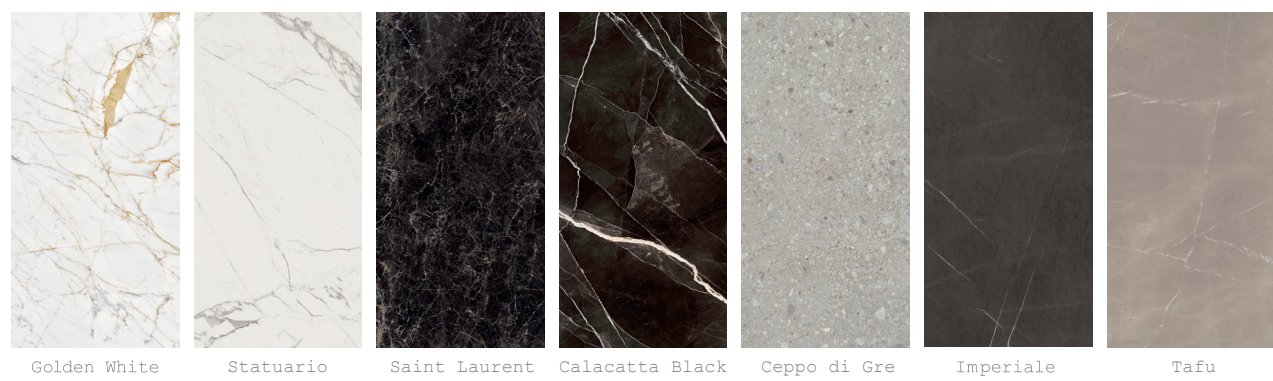

Wood Panel (Max Size 900×2,700)

木目柄のオレフィンシートを使用した壁面パネルです。基本ラインナップとして9種類。
※市販品のオレフィンシートでも製作可能です

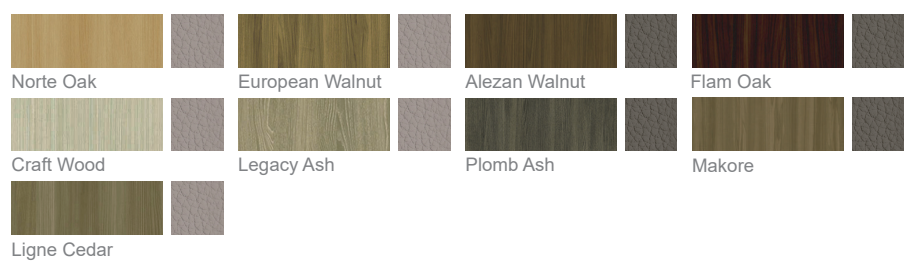

Frame Color



Letre

Option



Chest ¥250,000 wood color : Legacy Ash
Jewelry Box ¥470,000 wood color : Legacy Ash



Dresser ¥630,000 wood color : Legacy Ash

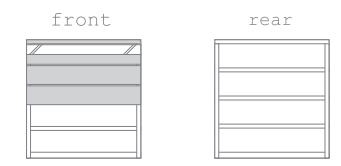
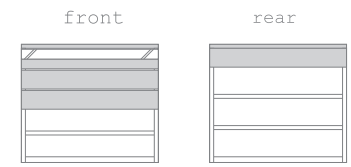

Drawer W900 ¥700,000 wood color : Legacy Ash
Drawer W700 ¥700,000 wood color : Legacy Ash

※上記のほかに Drawer W1200 もございます。

Teni

Raiki Loves **MARAZZI**



Teni frame color : Olive Brown / glass color : Grey
panel : Golden White

¥3,670,000

Teni

59

Raiki Loves **MARAZZI**



Teni frame color : Platinum Beige / glass color : Grey
panel : Saint Laurent

¥4,750,000

Teni

Raiki Loves **MARAZZI**



Teni frame color : Ash Silver / glass color : White
panel : Statuario Book Match

¥3,310,000

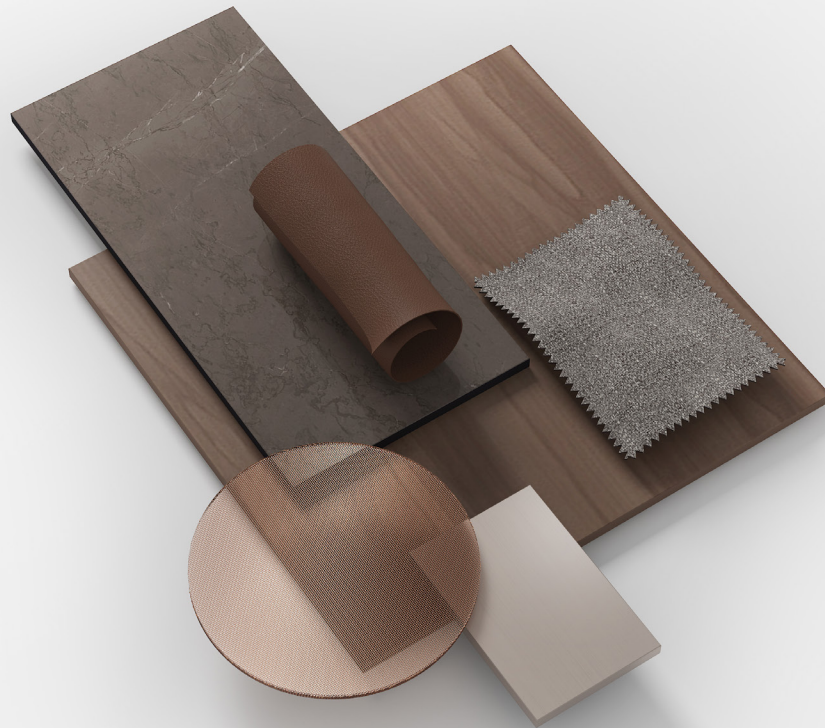

Teni

Detail

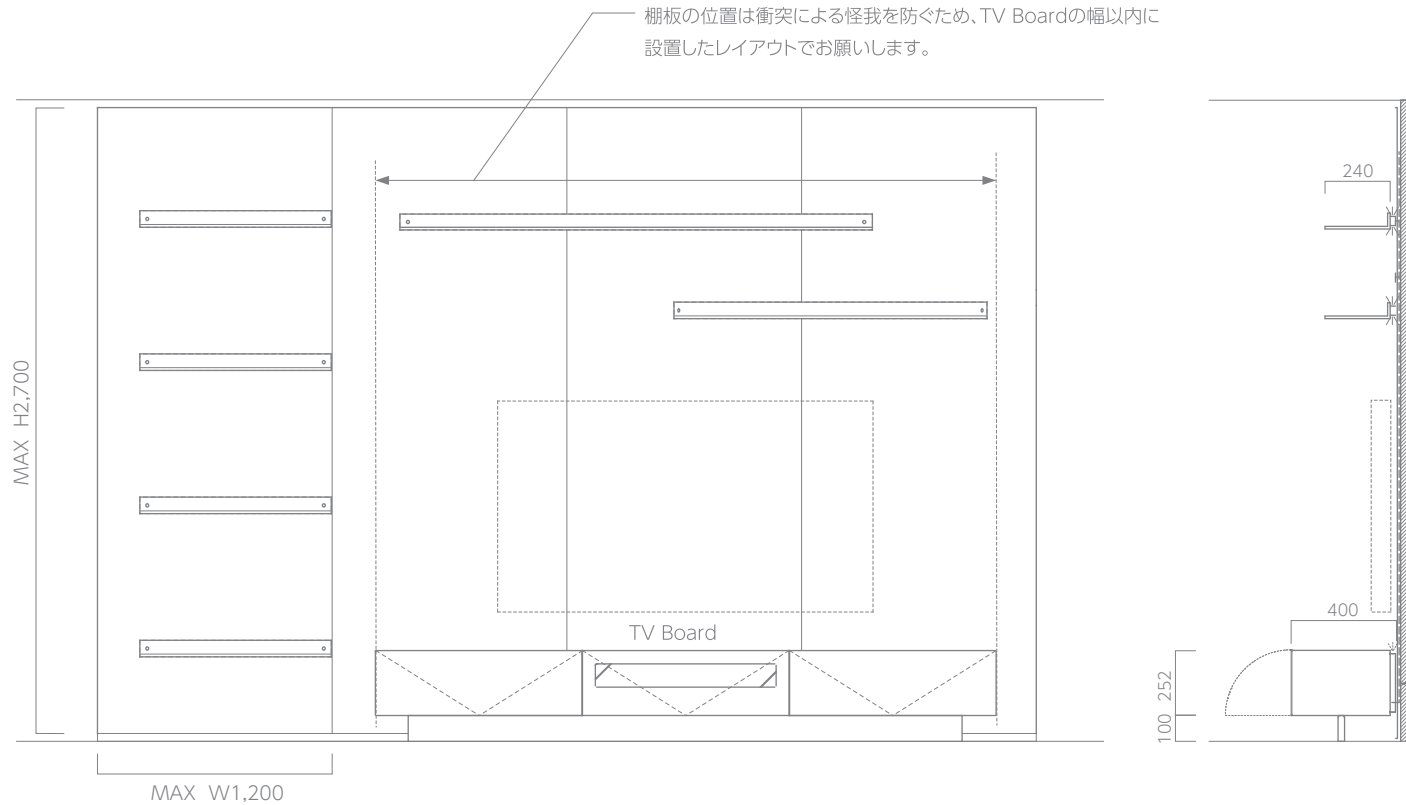

※危険を伴うレイアウトの場合は、棚位置の変更をお願いする場合がございます。

Stone Panel

Raiki Loves **MARAZZI**

Max Size 900×2,700

※Imperiale と Ceppo di Gre のみMax Size 1,200×2,400

¥400,000/列

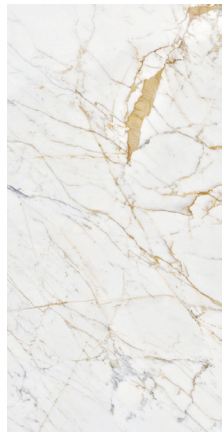

Golden White

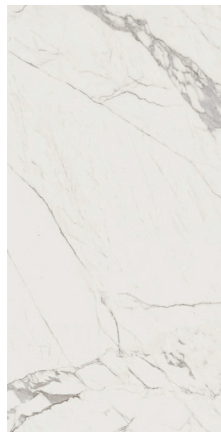

Statuario



Saint Laurent

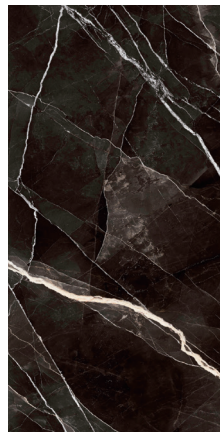

Calacatta Black



Ceppo di Gre ※



Imperiale ※



Tafu

Teni

Detail

TV Board

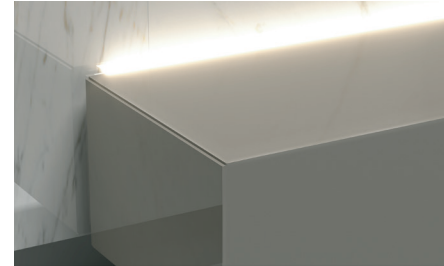

Color

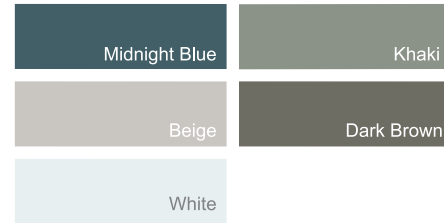

家具は2連と3連の2タイプ。扉は下開き式でソフトダウンステー付。
塗装は鏡面仕上げとなります。ガラス付の扉であればリモコン受信
可能のため、収納した状態でAV機器を利用することができます。

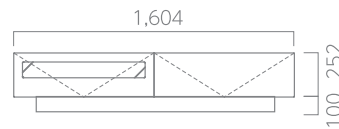

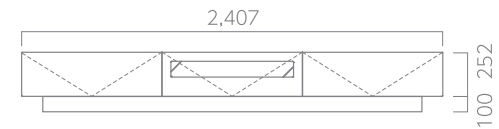

2span
¥590,000

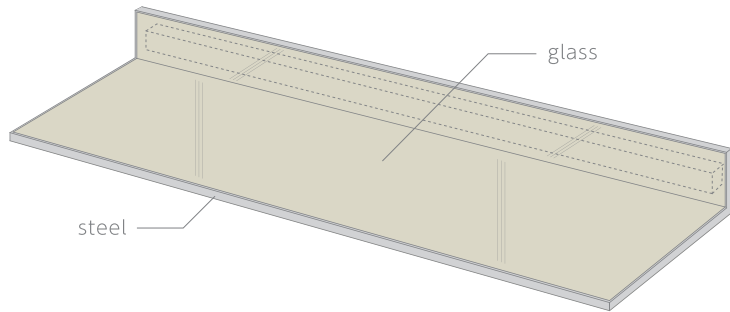

3span
¥790,000

Board



	L600	¥110,000
	L800	¥130,000
	L1200	¥160,000
	L1400	¥180,000
	L2000	¥220,000





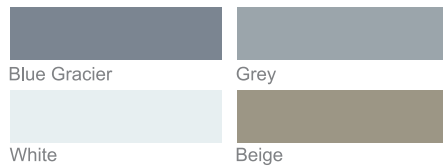

Steel Color

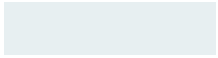

Paint Glass Color



Combination

		steel	×	glass
Ash Silver	×		×	
Platinum Beige	×		×	
Olive Brown	×		×	
Dark Chocolat	×		×	

Lounge



Sofa sofa material : ZINC top color : Moorland Fog
 leg color : Platinum Beige body color : Makore

¥3,925,000

Lounge

67



Sofa sofa material : White Leather
leg color : Platinum Beige

top color : Statuario Maximus
body color : European Walnut

¥4,606,000

Lounge



Sofa sofa material : ZINC top color : Moorland Fog
leg color : Platinum Beige body color : Makore

¥3,925,000

"Raiki" embodies the aesthetic sense that Japanese people have inherited since ancient times. The tension created by cutting waste to the utmost limit makes its quality stand out to the utmost.

The refined Raiki harmonizes with the space without being assertive, and even enhances the quality of the "place".

Lounge



Sofa sofa material : ZINC top color : Moorland Fog
 leg color : Platinum Beige body color : Makore

¥3,925,000

Lounge



Sofa sofa material : ZINC top color : Moorland Fog
 leg color : Platinum Beige body color : Makore

¥3,925,000

Lounge

Detail

Size Pattern	198	¥620,000
	138	¥500,000
	98	¥410,000

198

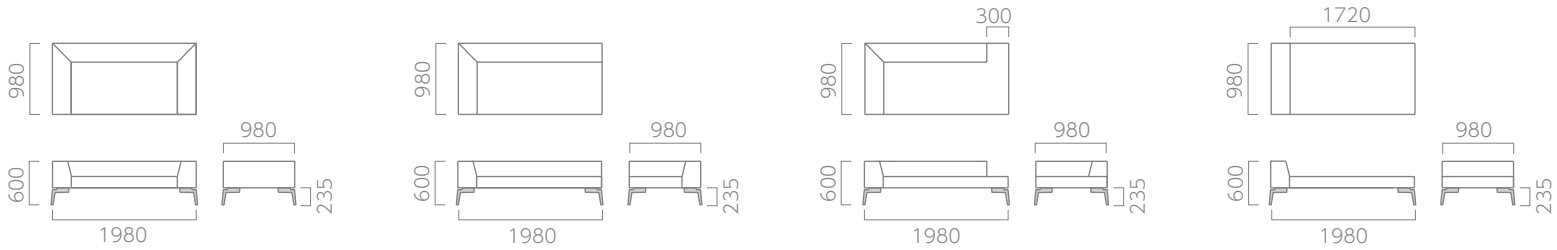

138

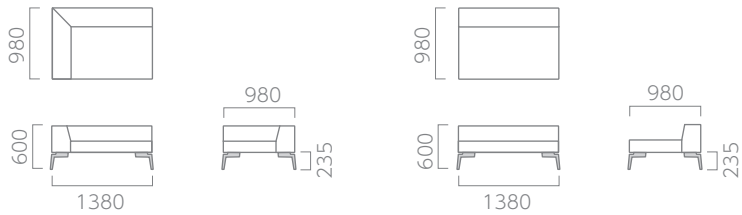

98

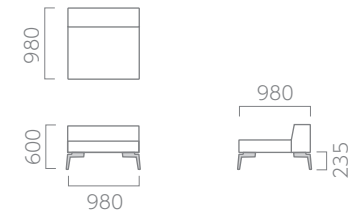

ottoman

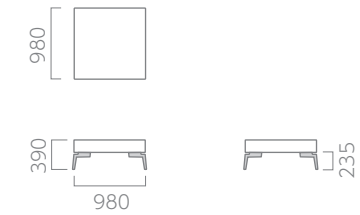

Combination Pattern

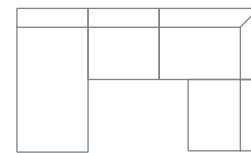
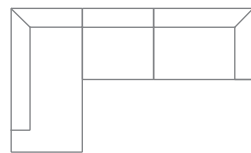
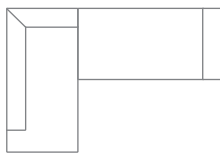
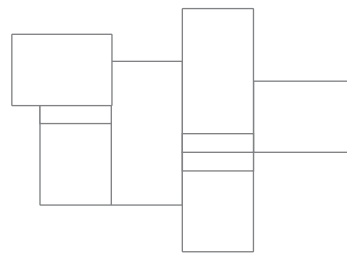
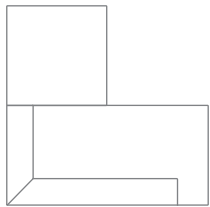
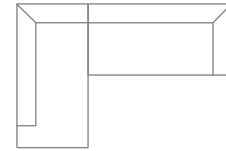
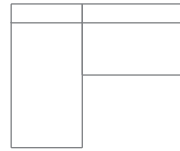
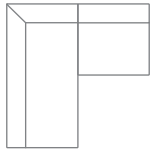

Lounge

Detail

Table

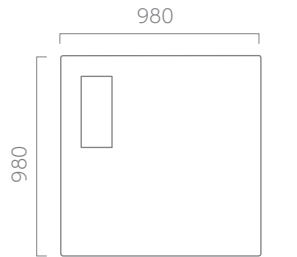

¥590,000

Side Table

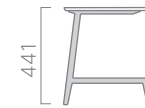
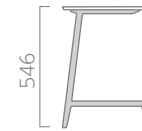
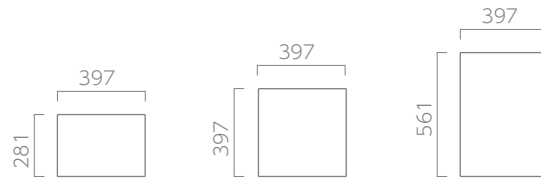

¥290,000 set

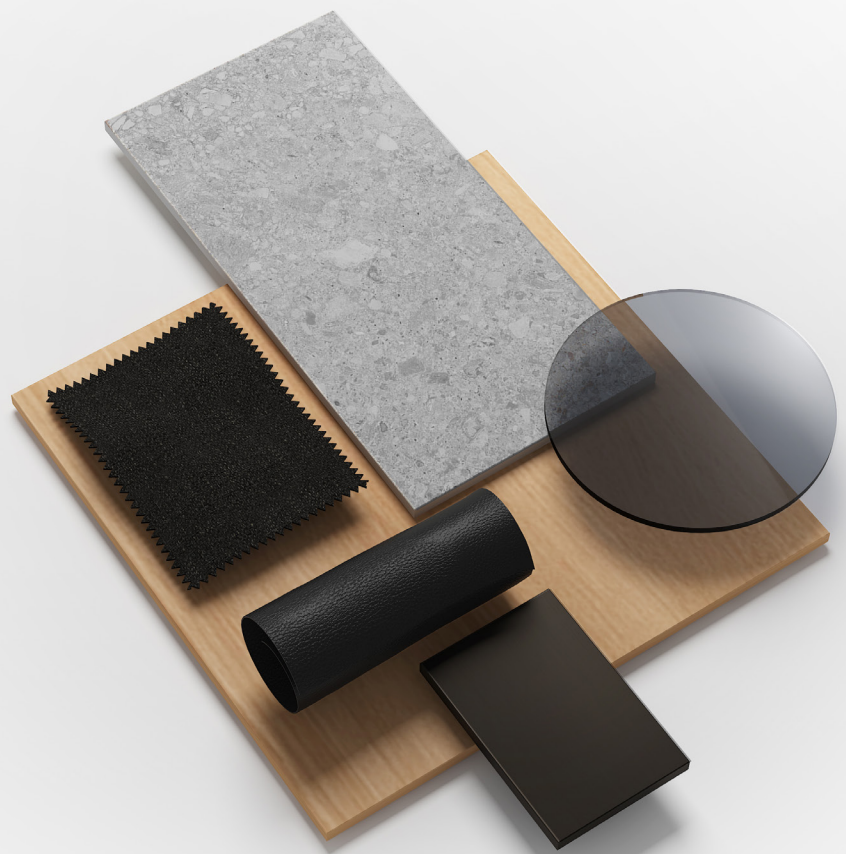

Lounge

Detail

Sofa

- Fabric
 - VEGAS
 - Natural
 - Stone
 - Chetnut
 - Zinc
 - Coal
 - Charcoal
 - Burnt Orange
 - Air Force
 - Mediterranean
 - OLENDER
 - Teal
 - Blue
 - Creram
 - Glacier
 - Ash
 - Bark
- Ultrasuede
 - Sea Salt
 - Silver Gray
 - Charcoal
 - Deep French Gray
 - Cappuccino
 - Branch
 - Moss
 - Lime
 - Eucalyptus
 - Brittany
 - Snow Blue
 - Steel Blue
 - Malibu
 - Papyrus
 - Camel
 - Ginger
 - Canyon
 - Madeira
 - African Violet
 - Marron glaces
- Leather
 - Black
 - White
 - Brown



Raiki



■ 販売元・製造元

辻産業株式会社：大阪府泉南郡田尻町吉見 355-5 tel：072-465-6347 fax：072-466-3653

Raiki Store Osaka：大阪府大阪市中央区西心斎橋 1-5-5 アーバン Bld. 心斎橋 5F tel：06-6732-8992 mail：info@tsujisangyo.com

Raiki Store Fukuoka：福岡県福岡市中央区天神 1-1-1 アクロス福岡 B1F tel：092-791-8709 mail：info@tsujisangyo.com

■ 関東圏販売総代理

コンフォート株式会社(大手町ショールーム)：東京都千代田区大手町 1-3-1 JA ビル15F tel：03-6372-6180 fax：03-6372-6183

販売・取扱店

※ カタログに記載されている商品の外観・仕様・価格などは商品改良のために予告なく変更することがありますので、あらかじめご了承ください。

また、使用されている CG 画像及び写真の色は印刷のため、実際の製品の色と多少異なる場合があります。

※ 本カタログには、特注色も掲載されています。